

HBS/4/6600/33

Compression Fittings

Stainless Steel Fittings

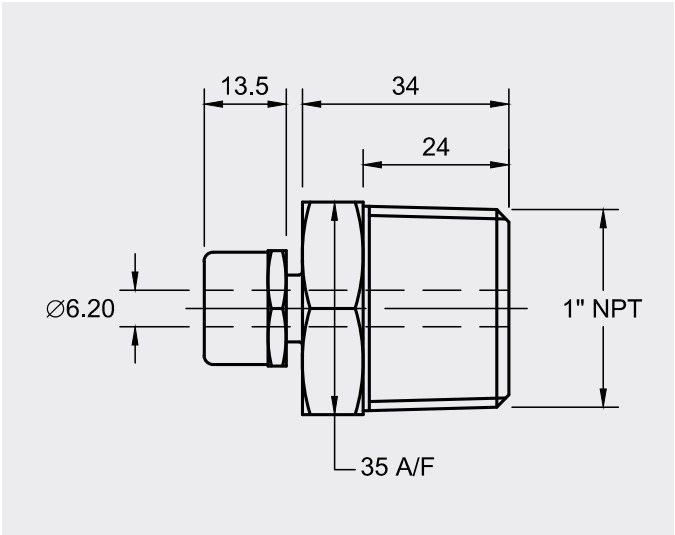

The HBS/4/6600/33 ATEX Exd compression fitting is manufactured from high quality 316 stainless steel. This fitting has a 1" NPT thread and is suitable for use with 6mm diameter mineral insulated cable.

Material	316 Stainless Steel
Thread Size	1" NPT
Bore Ø	6mm
Approvals	ATEX Exd

Approval	Classification	Certificate #
ATEX Exd	II 2 GD	Sira 08ATEX1242