

HBS/4/6600/22

Compression Fittings

Stainless Steel Fittings

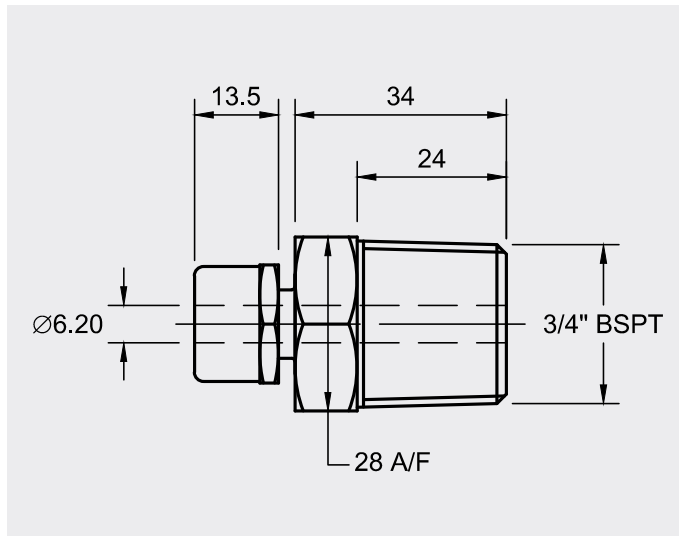

The HBS/4/6600/22 ATEX Exd compression fitting is manufactured from high quality 316 stainless steel. This fitting has a 3/4" BSPT thread and is suitable for use with 6mm diameter mineral insulated cable.

Material	316 Stainless Steel
Thread Size	3/4" BSPT
Bore Ø	6mm
Approvals	ATEX Exd

Approval	Classification	Certificate #
ATEX Exd	II 2 GD	Sira 08ATEX1242