

HBS/4/6600/16

Compression Fittings

Stainless Steel Fittings

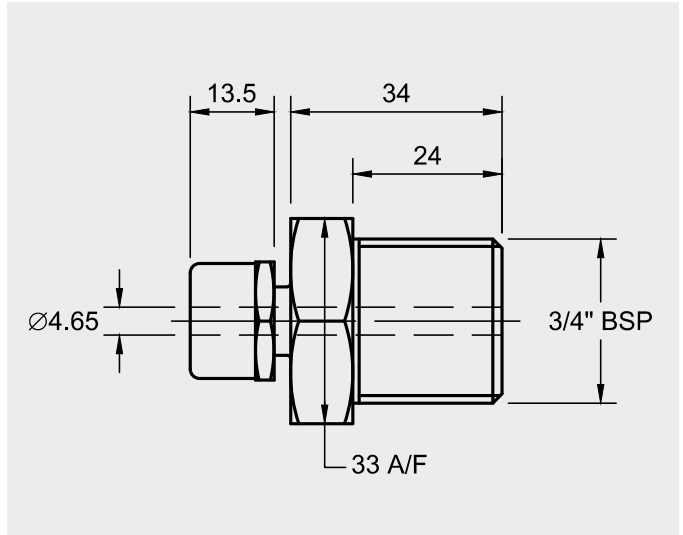

The HBS/4/6600/16 ATEX Exd compression fitting is manufactured from high quality 316 stainless steel. This fitting has a 3/4" BSPP thread and is suitable for use with 4.5mm diameter mineral insulated cable.

Material	316 Stainless Steel
Thread Size	3/4" BSPP
Bore Ø	4.5mm
Approvals	ATEX Exd

Approval	Classification	Certificate #
ATEX Exd	II 2 GD	Sira 08ATEX1242