

# HBS/4/6600/1

## Compression Fittings

Stainless Steel Fittings

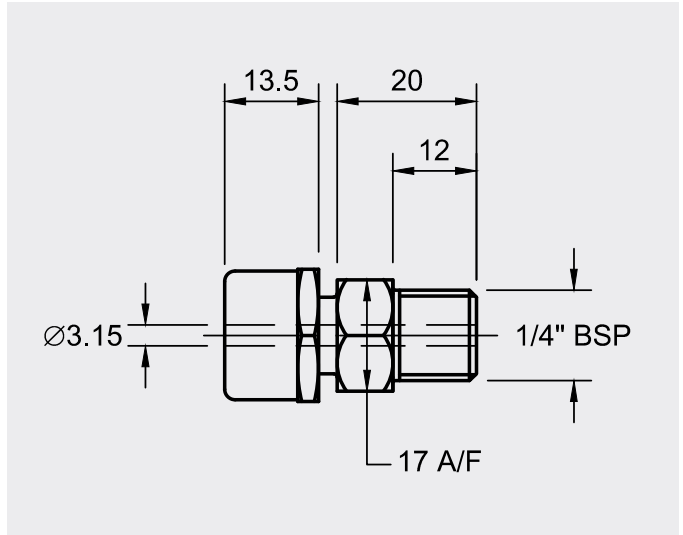

The HBS/4/6600/1 ATEX Exd compression fitting is manufactured from high quality 316 stainless steel. This fitting has a 1/4" BSPP thread and is suitable for use with 3mm diameter mineral insulated cable.

<b>Material</b>	316 Stainless Steel
<b>Thread Size</b>	1/4" BSPP
<b>Bore Ø</b>	3mm
<b>Approvals</b>	ATEX Exd

Approval	Classification	Certificate #
ATEX Exd	II 2 GD	Sira 08ATEX1242